

GMORS[®]

Seals to your heart

**Sealing Solutions for
Pneumatic Automation**



Low Friction Pneumatic Solutions

Low friction seals play an important role in pneumatic applications for the optimization of performance and reduction of excessive wear and tear.

In meeting with this requirement, GMORS has developed a series of special internally lubricated compounds.

Based on our test results comparing our standard compounds to these special internally lubricated compounds, the frictional force for rubber-metal contacts for the same application has been significantly reduced.

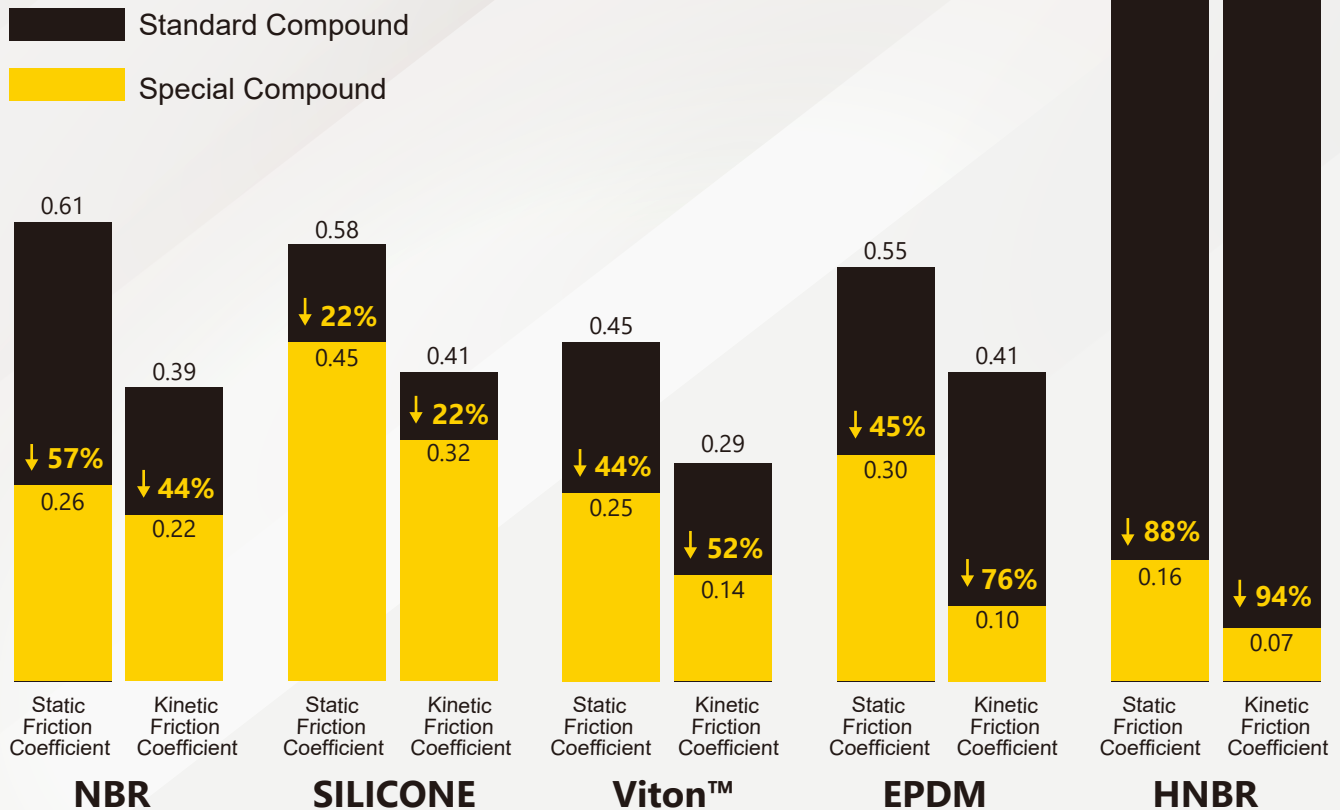



Sealing solutions for HYDRAULIC CYLINDER

Excellent Sealing Performance

Resistant to High Pressure and Abrasion



UA2 Wiper/Rod Seal

FKM 90 Black | NBR 85 Black

≤ 1.0 m/s

-10°C ~ 150°C | -35°C ~ 80°C

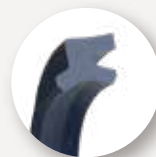

UA4 Wiper/Rod Seal

TPU 95 Gray/Dark Blue

≤ 1.0 m/s

-30°C ~ 80°C



UC6 Piston Seal

NBR 85 Black | FKM 90 Black

≤ 14 Mpa ≤ 1.0 m/s

-35°C ~ 80°C | -10°C ~ 150°C

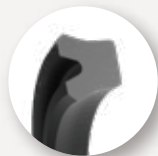

UF1 Piston/Rod Seal

NBR 85 Black | FKM 90 Black

≤ 14 Mpa ≤ 1.0 m/s

-35°C ~ 80°C | -10°C ~ 150°C



UF2 Piston/Rod Seal

TPU 95 Gray/Dark Blue

≤ 35 Mpa ≤ 0.8 m/s

-35°C ~ 80°C



UF4 Piston/Rod Seal

TPU 95 Gray/Dark Blue

≤ 21 Mpa ≤ 0.8 m/s

-35°C ~ 80°C



UH1 Piston/Rod Seal

TPU 95 Black

≤ 35 Mpa ≤ 0.8 m/s

-35°C ~ 80°C

*With NBR 70 O-Ring

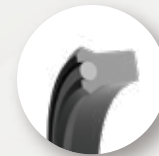

UH2 Piston/Rod Seal

TPU 95 Black

≤ 35 Mpa ≤ 0.8 m/s

-30°C ~ 80°C

*With NBR 70 O-Ring

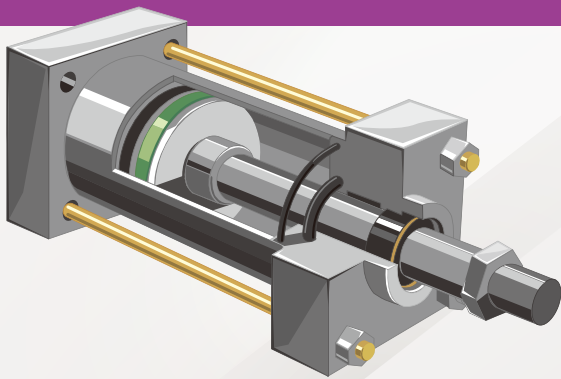

Sealing solutions for PNEUMATIC CYLINDER

Completed Specification and Widely Application

Low Friction and Long Lifetime



UA6 Wiper/Rod Seal

FKM 80 Green

≤ 1.6 Mpa ≤ 1.0 m/s

-10°C ~ 150°C

*Metal:SUS304

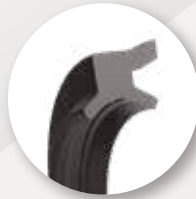

UA7 Wiper/Rod Seal

TPU 90 Brown

≤ 1.6 Mpa ≤ 1.0 m/s

-40°C ~ 80°C



UA25 Wiper/Rod Seal

NBR 80 Black

≤ 1.6 Mpa ≤ 1.0 m/s

-35°C ~ 80°C



UB1 Wiper/Rod Seal

TPU 95 Gray/Green

≤ 1.6 Mpa ≤ 1.0 m/s

-35°C ~ 80°C

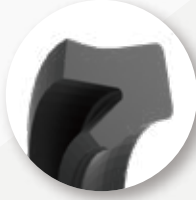

UB3 Rod Seal

NBR 75 Black | FKM 75 Black

≤ 1.0 Mpa ≤ 1.0 m/s

-35°C ~ 80°C | -10°C ~ 150°C

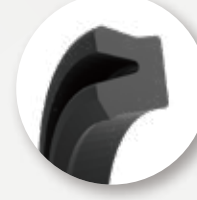

UC3 Piston Seal

NBR 85 Black | FKM 75 Black

≤ 1.6 Mpa ≤ 1.0 m/s

-30°C ~ 80°C | -20°C ~ 200°C



UC36 Piston Seal

NBR 80 Black	FKM 75 Black
--------------	--------------

≤ 1.2 Mpa	≤ 1.0 m/s
-----------	-----------

-35°C ~ 80°C	-20°C ~ 200°C
--------------	---------------

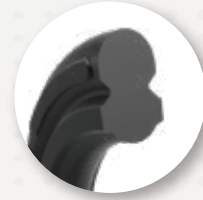

UC7 Piston Seal

NBR 75 Black	FKM 75 Black
--------------	--------------

≤ 1.0 Mpa	≤ 1.0 m/s
-----------	-----------

-35°C ~ 80°C	-20°C ~ 200°C
--------------	---------------



UE1 Damper Seal

NBR 85 Black	FKM 90 Black
--------------	--------------

≤ 1.0 Mpa	≤ 1.0 m/s
-----------	-----------

-35°C ~ 80°C	-20°C ~ 200°C
--------------	---------------

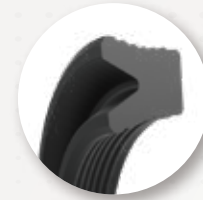

UF5 Piston/Rod Seal

NBR 75 Black	FKM 75 Black
--------------	--------------

≤ 1.0 Mpa	≤ 1.0 m/s
-----------	-----------

-35°C ~ 80°C	-25°C ~ 200°C
--------------	---------------



UF6 Piston/Rod Seal

NBR 75 Black	FKM 70 Black
--------------	--------------

≤ 0.8 Mpa	≤ 1.0 m/s
-----------	-----------

-35°C ~ 80°C	-10°C ~ 150°C
--------------	---------------

SOLENOID VALVE Sealing Solutions

Easy to Install & Smooth in Movement

Lowest Friction and Self-lubricant



Customized Valve Seals / Gasket



O-Rings



GMORS PV Series



GAS SPRINGS Sealing Solutions

Durable, Compact, Smooth and Low Loss

Low Friction and Long Life



Metal-Bonded U-Cup Seals

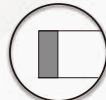

PTFE Guide Rings



O-Rings



Customized U-Cup Seals



PRESSURE REGULATOR Sealing Solutions

Excellent Long Term Sealing to Prevent Dust and Leakage

Stable Fluid Control and Low Compression Set



ED Rings (DIN 3869)



O-Rings &
PTFE Back-up Rings



Customized Washers

GRIPPER Sealing Solutions

10 Million Lifetime Testing

Lowest Friction and High Frequency



U-cup Seals



O-Rings



Customized Washers

AIR SOURCE UNITS Sealing Solutions

Extraordinary Sealing Function

Precise Design and Excellent Flexibility



U-cup Seals



O-Rings



Customized Diaphragms



LINEAR WAY Sealing Solution

Speedy Movement with Minor Noise

Low Friction with the Lowest Vibration Noise



Metal-Bonded Rubber Seals



Customized Gaskets





YouTube



Catalog
Download

GMORS®
Seals to your heart

Ge Mao Rubber Industrial Co., Ltd.

No. 15, Kung Yeh East 4th Rd., Lukang,
Chang Hua 505, Taiwan

 inquiry@gmors.com

 +886.4.7810288

 www.gmors.com